

# alpha Q13L Pro

operating instructions



Thank you for choosing Kullhaus.

Please read instructions before using the dehumidifier and keep it for future reference.

## CONTENTS

Safety precautions .....	3-4
Safety Regulations for Service and Repair Work.....	5-6
Product Description .....	7
Technical Specifications.....	8
Placement .....	8
Operating Instructions .....	9-12
Cleaning and Maintenance .....	13
Troubleshooting .....	14
Display Error Codes .....	15
KULLSAVE .....	15
Storage .....	15
Smart Connection Operation Guide .....	16-19
Conditions of Warranty .....	20

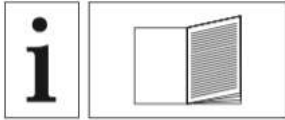

**Only for home use / power source 220-240V/50Hz**

Read the USER MANUAL carefully before operation.

This device is for home use only and not for commercial, industrial or outdoor use.

We reserve the right for any error in the text or images and any necessary changes made to technical data.



Service personnel are required to carefully read the USER MANUAL and SERVICE MANUAL before operation. Failure to abide by this warning could result in an explosion, injury and property damage.



Recycle unwanted materials instead of disposing of them. All appliances and packaging should be sorted and tendered at a regional recycling centre and be processed in an ecological manner.



This unit uses a flammable refrigerant.

If refrigerant leaks and comes in contact with fire or heating part, it will create harmful gas and there is risk of fire.



Before putting the device into operation for the first time, place it in an upright position for at least 3 hours to stabilize the compressor fluids.

## SAFETY INSTRUCTION

- Read the operating instructions carefully before using the dehumidifier & keep it for future reference.
- To avoid electric shock, fire or injury, please read the user manual carefully before using the appliance and keep it for future reference.
- This appliance can be used by children aged from 8 years and above and persons with reduced physical, sensory or mental capabilities or lack of experience and knowledge if they have been given supervision or instruction concerning use of the appliance in a safe way and understand the hazards involved. Children shall not play with the appliance. Cleaning and user maintenance shall not be made by children without supervision.
- The unit is designed only for use with R-290 (propane) gas as the designated refrigerant.
- **THE REFRIGERANT LOOP IS SEALED. ONLY A QUALIFIED TECHNICIAN SHOULD ATTEMPT TO SERVICE!**
- Do not discharge the refrigerant into the atmosphere.
- R-290 (propane) is flammable and heavier than air.
- It collects first in low areas but can be circulated by the fans.
- If propane gas is present or even suspected, do not allow untrained personnel to attempt to find the cause.
- The propane gas used in the unit has no odour.
- The lack of smell does not indicate a lack of escaped gas.
- If a leak is detected, immediately evacuate all persons from the store, ventilate the room and contact the local fire department to advise them that a propane leak has occurred.
- Do not let any persons back into the store until the qualified service technician has arrived and that technician advises that it is safe to return to the store.
- No open flames, cigarettes or other possible sources of ignition should be used inside or in the vicinity of the units.
- Component parts are designed for propane and non-incentive and non-sparking. Component parts shall only be replaced with identical repair parts.
- If the supply cord is damaged, it must be replaced by the manufacturer, its service agent or similarly qualified persons in order to avoid a hazard.
- The appliance shall be disconnected from its power source during maintenance.
- Ensure the unit is far away from fire, inflammable, or explosive objects.
- Do not use means to accelerate the defrosting process or to clean, other than those recommended by the manufacture.

## SAFETY INSTRUCTION

The appliance shall be stored in a room without continuously operation sources (for example: open flames, an operating gas appliance or an operating electric heater).

The appliance shall be stored so as to prevent mechanical damage from occurring.

Do not piece or burn, even after use.

Pipework shall be protected from physical damage.

**THE MACHINE MAY ONLY BE INSTALLED IN A ROOM WITH MINIMUM FLOOR AREA OF 4 m<sup>2</sup>.**

Compliance with national gas regulations shall be observed.

Keep any required ventilation openings clear of obstruction.

The appliance shall be stored in a well-ventilated area where the room size corresponds to the room area as specified for operation.



### Warning on Refrigerant R290

- Failure to abide by this warning could result in an explosion, death, injury and property damage.
- Any person who is involved with working on or breaking into a refrigerant circuit should hold a current valid certificate from an industry-accredited assessment authority, which authorizes their competence to handle refrigerants safely in accordance with an industry, recognized assessment specification.
- Servicing shall only be performed as recommended by the equipment manufacturer. Maintenance and repair requiring the assistance of other skilled personnel shall be carried out under the supervision of the person competent in the use of flammable refrigerants.

# SAFETY REGULATIONS FOR SERVICE AND REPAIR WORK

**Repairs must only be carried out by authorised service personnel and only using genuine spare parts. Please follow these warnings when servicing a dehumidifier with R290.**

## Checks to the area

Prior to beginning work on systems containing flammable refrigerants, safety checks are necessary to ensure that the risk of ignition is minimized. For repair to the refrigerating system, the following precautions shall be complied with prior to conducting work on the system.

## Work procedure

Work shall be undertaken under a controlled procedure so as to minimize the risk of a flammable gas or vapour being present while the work is being performed.

## General work area

All maintenance staff and others working in the local area shall be instructed on the nature of work being carried out. Work in confined spaces shall be avoided. The area around the workspace shall be sectioned off. Ensure that the conditions within the area have been made safe by control of flammable material.

## Checking for presence of refrigerant

The area shall be checked with an appropriate refrigerant detector prior to and during work, to ensure the technician is aware of potentially flammable atmospheres. Ensure that the leak detection equipment being used is suitable for use with flammable refrigerants, i.e. no sparking, adequately sealed or intrinsically safe.

## Presence of fire extinguisher

If any hot work is to be conducted on the refrigeration equipment or any associated parts, appropriate fire extinguishing equipment shall be available to hand. Have a dry powder or CO<sup>2</sup> fire extinguisher adjacent to the charging area.

## No ignition sources

No person carrying out work in relation to a refrigeration system which involves exposing any pipe work that contains or has contained flammable refrigerant shall use any sources of ignition in such a manner that it may lead to the risk of fire or explosion. All possible ignition sources, including cigarette smoking, should be kept sufficiently far away from the site of installation, repairing, removing and disposal, during which flammable refrigerant can possibly be released to the surrounding space. Prior to work taking place, the area around the equipment is to be surveyed to make sure that there are no flammable hazards or ignition risks. "No Smoking" signs shall be displayed.

## Ventilated area

Ensure that the area is in the open or that it is adequately ventilated before breaking into the system or conducting any hot work. A degree of ventilation shall continue during the period that the work is carried out. The ventilation should safely disperse any released refrigerant and preferably expel it externally into the atmosphere.

## Checks to the refrigeration equipment

Where electrical components are being changed, they shall be fit for the purpose and to the correct specification. At all times the manufacturer's maintenance and service guidelines shall be followed. If in doubt consult the manufacturer's technical department for assistance.

The following checks shall be applied to installations using flammable refrigerants:

- The charge size is in accordance with the room size within which the refrigerant containing parts are installed;
- The ventilation machinery and outlets are operating adequately and are not obstructed;
- If an indirect refrigerating circuit is being used, the secondary circuit shall be checked for the presence of refrigerant;
- Marking to the equipment continues to be visible and legible. Markings and signs that are illegible shall be corrected;
- Refrigeration pipe or components are installed in a position where they are unlikely to be exposed to any substance which may corrode refrigerant containing components, unless the components are constructed of materials which are inherently resistant to being corroded or are suitably protected against being so corroded.

## Checks to electrical devices

Repair and maintenance to electrical components shall include initial safety checks and component inspection procedures. If a fault exists that could compromise safety, then no electrical supply shall be connected to the circuit until it is satisfactorily dealt with. If the fault cannot be corrected immediately but it is necessary to continue operation, an adequate temporary solution shall be used. This shall be reported to the owner of the equipment so all parties are advised.

Initial safety checks shall include:

- those capacitors are discharged: this shall be done in a safe manner to avoid possibility of sparking;
- that there no live electrical components and wiring are exposed while charging, recovering or purging the system;
- that there is continuity of earth bonding.

**Releasing refrigerant into atmosphere is strictly forbidden!**

## PRODUCT DESCRIPTION

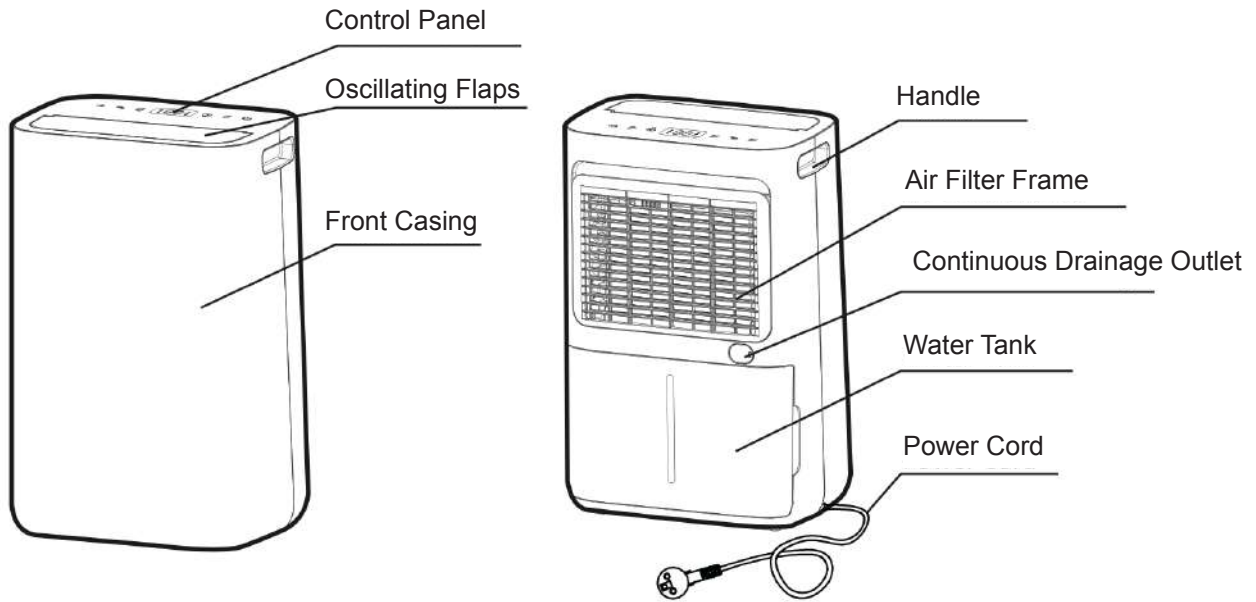

## CONTROL PANEL DESCRIPTION

1. Power Button
2. Manual Button
3. Timer Button / Child Lock Button
4. Oscillation Button/ Wi-Fi Button
5. Ionizer Button
6. Mode Button





 Laundry Indicator

 Wi-Fi Indicator

 Sleep Mode Indicator

 Timer Indicator

 Ionizer Indicator

 Tank Full Indicator



## TECHNICAL SPECIFICATIONS

Model		alpha Q13 Pro
Power Supply		220-240V~ 50Hz
Dehumidifying Capacity	30°C 80%	13L/day
	27°C 60%	7L/day
Rated Power		145 watts / 0.95A (27°C 60%)
Air Flow	High	95 m³/h
	Low	70 m³/h
Noise Level	High	39 dB(A)
	Low	35 dB(A)
Fan speeds		2
Water Tank Capacity		2.3L
Operating Temperature		5°C–35°C
Timer		1–24 hours
Refrigerant / Charge		R290 / 0,045 kg
Weight		10,3 kg
Dimension	(W×D×H)	308 x 209 x 445 mm

The above technical data is for reference only. We reserve the right to modify them without notice.

## PLACEMENT

Check the dehumidifier for any transport damage. In case of damage, you should contact with seller immediately.

- Make sure that the dehumidifier is standing firmly on a flat surface
- Make sure that the mains lead is easily accessible and is not damaged by sharp edges or is crushed in any way during use.
- If any part of your house suffers from severe humidity, the dehumidifier can be placed there first and then moved to another part of the house later.
- Ensure the dehumidifier is at a safe distance at least 50cm away from a wall or furniture.
- Never place the dehumidifier next to a radiator or heating appliance.

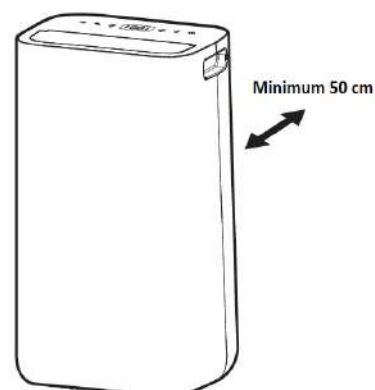

# OPERATING INSTRUCTIONS

## Note:

- Supply power should be in correspondence with the value on the nameplate, power outlet needs to be grounded.
- Do not use the device with power strip, as they may overheat and cause a fire. However, if necessary, use a good quality extension cord and first make sure that it is in excellent condition.
- Ensure the tank is correctly fitted, if the tank is full or not in place, the “Tank Full” indicator comes on and the dehumidifier will stop working.
- If the dehumidifier is turned off and then turned back on again immediately, it will take approximately 3 minutes to reach full power (compressor back to work).
- If the dehumidifier switched off by a power cut, it will automatically switch back on once the power is restored.
- The dehumidifier works best at normal room temperature, its efficiency is reduced if the ambient temperature falls to below 15°C.

## Switching On/Off the Unit





Connect the mains lead to socket. Press power button once to turn on the unit. By default, it runs on Manual Dehumidifying Mode. Press Power button once again to turn off the unit.

## Humidity Setting Control



Press Manual button once to enter Manual Dehumidifying Mode or to select desired level of humidity from CO-30%-35%-40%-45%-50%-55%-60%-65%-70%-75%-80%-CO.

Note: if ambient humidity lower than 30%, display shows.   
if ambient humidity higher than 90%, display shows. 

## Timer Setting

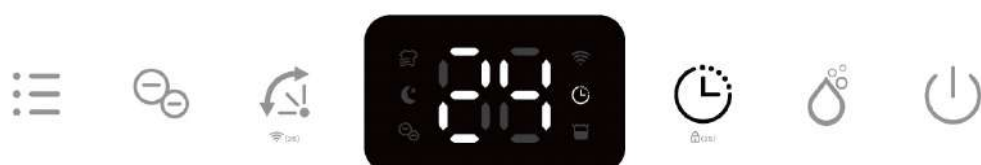

At ON Mode, press timer button consecutively to select your preferred timer duration for automatic shutoff setting. Its corresponding Timer indicator will be displayed on screen.

# OPERATING INSTRUCTIONS

## Oscillating Flaps



Oscillating flap oscillates from different angle for better air circulation and optimum diffusion of the dehumidified air throughout the room.

## Wi-Fi



Press the Oscillation button for 2 seconds to activate the WIFI function and enter into the distribution network mode, during the network configuration, the WIFI indicator flashes, after WIFI connected, the icon is on.

**Note:** Detailed operation, please refer to the manual «Smart Connection Operation Guide».

**Note:** Long press Oscillation button for 2 seconds can disconnect the WIFI.

## Built in Ionizer



The unit is equipped with built-in ionizer which produces negative ions to freshen up the air quality and to promote air purification through the elimination of air borne allergens and germs.

**Note:** If the fan stops working, anion function will automatically be deactivated.

## Laundry Drying Mode



Press Mode button once to select the Laundry Drying mode, its corresponding Laundry Drying indicator will be displayed on screen. The unit works in continuous dehumidification with high fan speed for 6 hours then switch off automatically.

# OPERATING INSTRUCTIONS

## Sleeping Mode



Press Mode button twice to select the Sleeping mode, its corresponding Sleeping indicator will be displayed on screen. The unit works in previous mode but in low fan speed and 10 seconds later, all indicators will be off.

**Note:** At Sleeping Mode, press any button to wake up the unit first then to operate as usual.

## Childlock Function

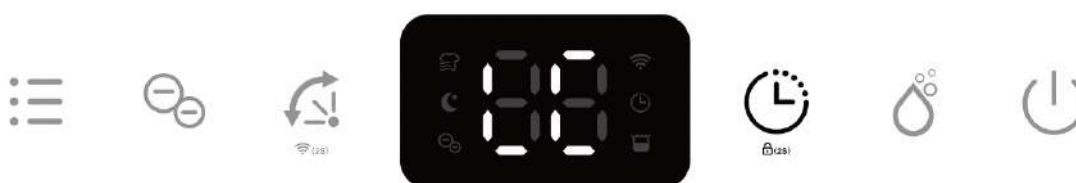

To prevent the mishandling by young children, unit is equipped with a Childlock function. Press timer button for 2 seconds to activate or deactivate the childlock function.

**Note:** After activating the childlock function, the LC will be displayed on screen, 3 seconds later, screen will show the current room humidity.

## Automatic Shut Off



When the water tank becomes full during normal use, the unit shuts off automatically with tank full indicator on the screen and buzzer alarm goes off for 5 times.

**Note:** If water tank is removed or not placed properly, above phenomenon will appear also.

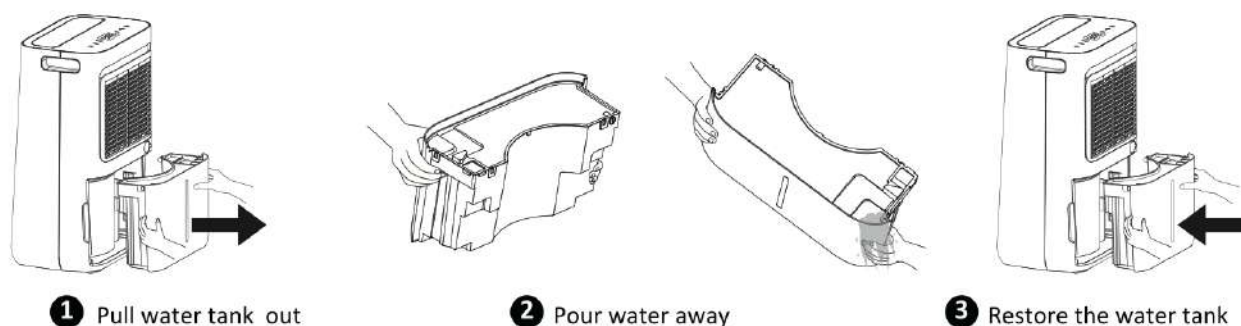

# OPERATING INSTRUCTIONS

## Automatic Defrost Feature



The unit is equipped with an automatic defrost feature. When room temperature is too low, compressor shuts off and unit runs on high fan speed setting until the frost has disappeared, no other setting can be made for this feature. Its corresponding indicator will be displayed on screen.

## Memory Feature

When power failure and after recovering, the unit will work with the mode prior to the shutdown. Means the humidity setting and working mode setting will be kept.

## Continuous Drainage Option

Continuous drainage option allows easy removal of collected water instead of manually emptying from the water tank when the environment is very high humidity.

1. Press Manual button to select the desired humidity value of CO.
2. Remove the rubber plug covering the drain hose connection.
3. Connect a suitable drain hose (14mm inner diameter) through the drainage outlet. Ensure that the hose is secure and tight to prevent leakage.
4. Always make sure the drainage hose is not blocked or obstructed to maintain a smooth flow.

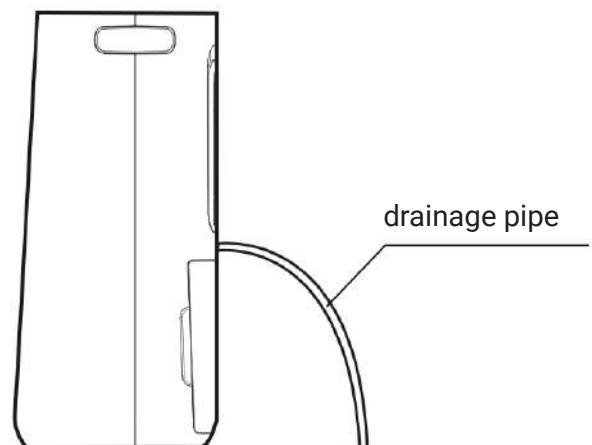
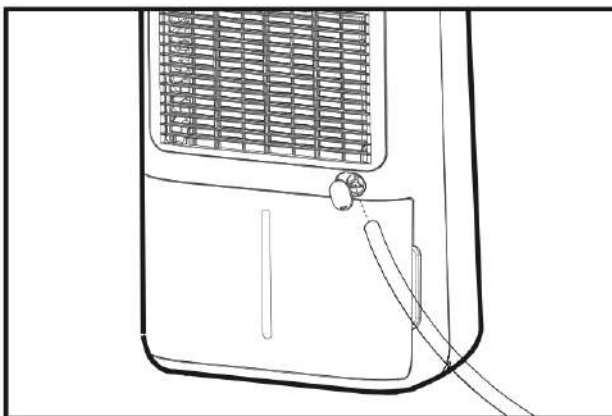

## CLEANING AND MAINTENANCE

To ensure the effectiveness of the dehumidifier, it is recommended to clean the unit at least every two weeks.

1. Turn the dehumidifier off and pull out the plug before cleaning.
2. Use a soft cloth to gently wipe the outer case to remove dust.
3. Vacuum clean the air inlet and outlet grilles of the dehumidifier.
4. Remove the water tank and wash it by hand using a mild detergent. Rinse it with Clean Water.

**Note:** DO NOT spray water directly onto the unit.

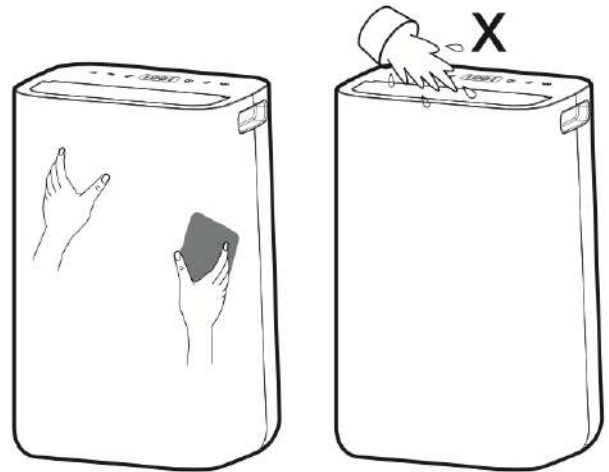

### Cleaning the Air Filter Frame

1. Remove the inlet frame from the back.
2. Wash the filter frame carefully in warm water, use a mild detergent if necessary.

**Note:** Do not wash the filter frame in a dishwasher.

3. Rinse the filter frame in clean water and let it dry before reinserting it.
4. Fit the filter frame back onto the unit.

**Note:** DO NOT use the dehumidifier without the Air Filter Frame in place.

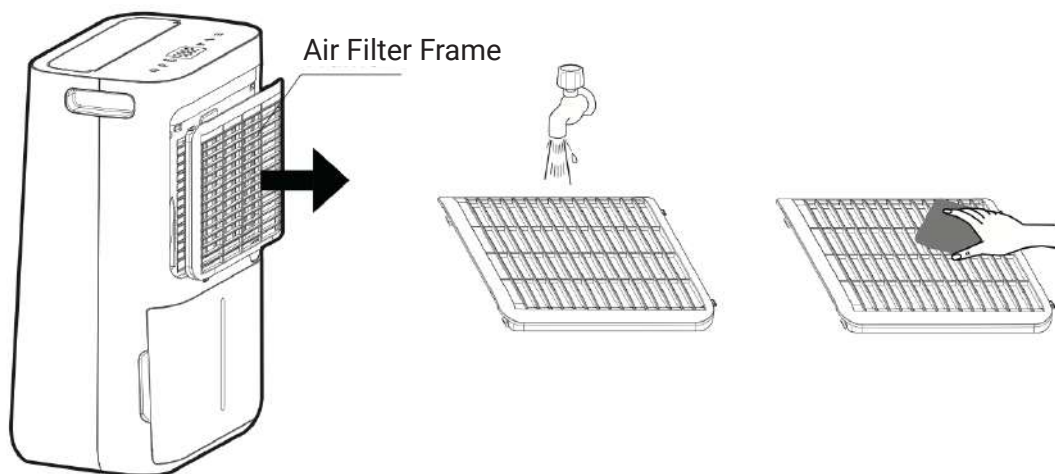

## TROUBLESHOOTING

Check the following before contacting technical support.

PROBLEM	POSSIBLE CAUSE	SOLUTION
The device does not work	The power is not connected	Insert the plug into the wall outlet
	The water tank is full	Empty the tank
	The tank has not been placed correctly	Place the tank correctly
Water removal capacity is too low	Runtime is too short	Be patient and wait
	Ambient temperature or humidity is too low	It is normal that the device does not dehumidify in these conditions
The device works, but reduces the relative humidity insufficiently	The house is too big	We recommend using a dehumidifier with a greater capacity
	There is too much ventilation	Reduce ventilation (e.g. close windows and shut doors)
	The air filter is clogged	Clean the filter
	The ambient humidity level is lower than the target humidity level set	Set the target humidity lower than ambient humidity
Dehumidifier is blowing out warm air	The dried air is passed over heating coils before it is blown into the room as part of the dehumidifying process	This is normal
Unusual noises	The dehumidifier is tilted or standing on an uneven surface	Place the dehumidifier upright on a stable, flat and dry surface
	The air filter is clogged	Clean the filter
	Loose or foreign particles inside the unit	Contact technical support
	Sound of flowing refrigerant	This is normal
Water on floor	There is residual water in tank, and the device is lurched too much by moving	Be careful when moving the tank
	Water tank may be damaged	Contact technical support
	Float for water auto-sensor is not in place	Contact technical support
	Internal drainage passage is blocked or obstructed	Contact technical support

## DISPLAY ERROR CODES

Please contact local distributor if any of the error codes below appears.

Display Code	Error	Solution
E1	Temperature sensor error	Contact technical support
E2	Humidity sensor error	Contact technical support

## KULLSAVE

### The Energy Savings Smart Operation

When the target relative humidity is reached, the unit will operate only the fan in low speed for 1 minute, then will stop for 15 minutes. The fan will then run for 1 minute to check the relative humidity.

If the relative humidity has risen above the target humidity (HS)+1%, the unit will start operating again. If the relative humidity remains below the target level, the unit will fall back to sleep and only the fan works in low speed for about 1 minute and then stops for 15 minutes.

## STORAGE

If the dehumidifier will not be used for a long period of time, take the following steps:

1. Remove the plug from the socket and empty the tank, make the tank and the dehumidifier dry completely, this may take a couple of days.
2. Clean the air filter as described above.
3. Ensure that the dehumidifier is in perfect condition for a safe use of the unit after a long period of storage.
4. Pack the device with the suitable packaging.
5. Store the dehumidifier in a dust-free and out of direct sunlight location, preferably covered with a sheet of plastic.



## APP Binding Device

Search an APP platform for «TuyaSmart» or scan the following QR code to download the APP.



### Step 1

Make sure the phone is connected to the WIFI at home, and turn on the Bluetooth device, tap the upper right corner of the home page+ to add device.

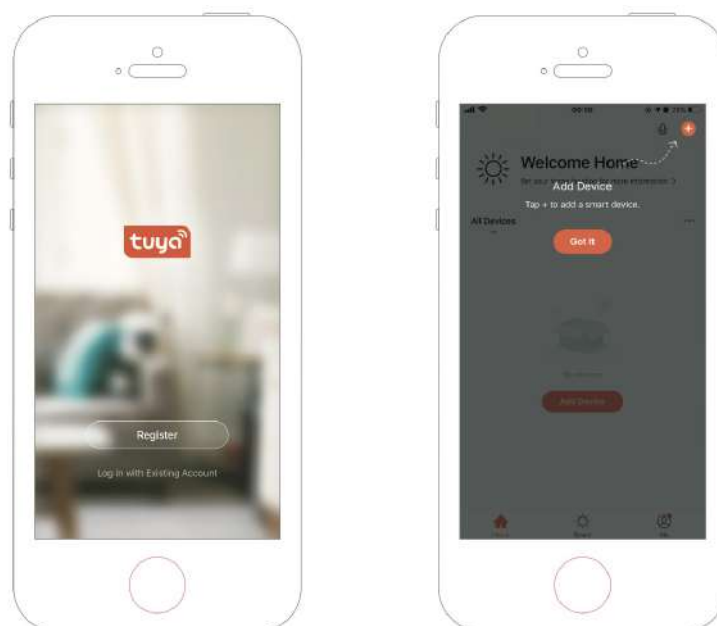

# SMART CONNECTION OPERATION GUIDE

## Step Two

Follow the guide to select the device to be configured, then enter the WiFi password.

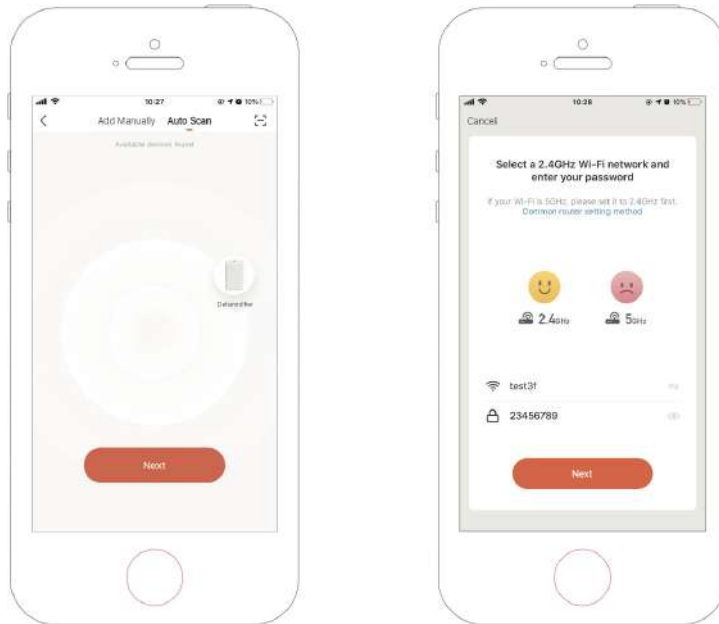

## Step 3

Complete the connection to set the dehumidifier with APP.

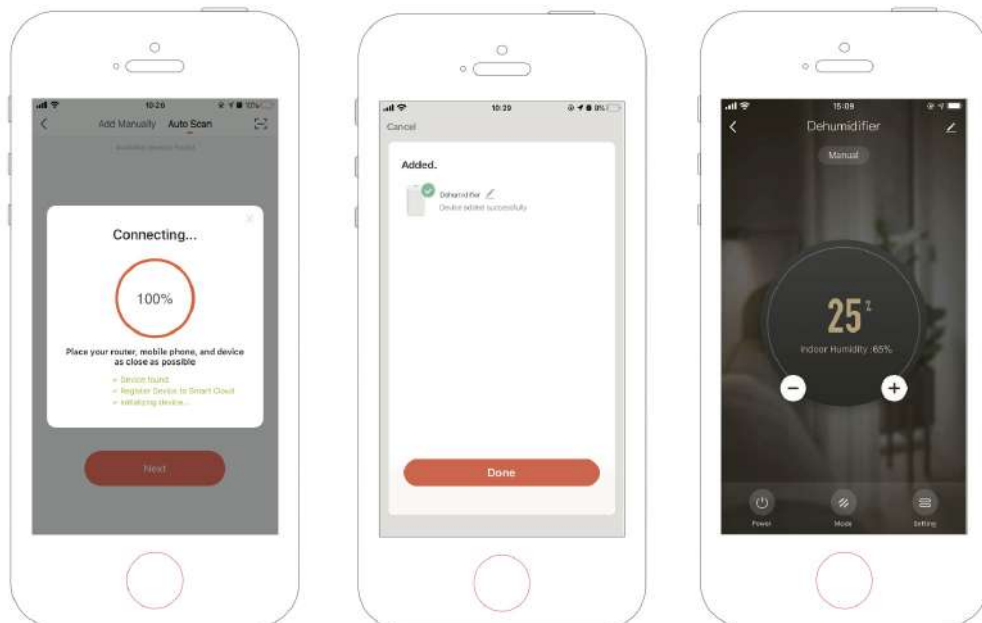

## Adding Device Manually

### Step 1

Tap Add Device on the home page or+ in the upper right corner to go to the Add Device page.

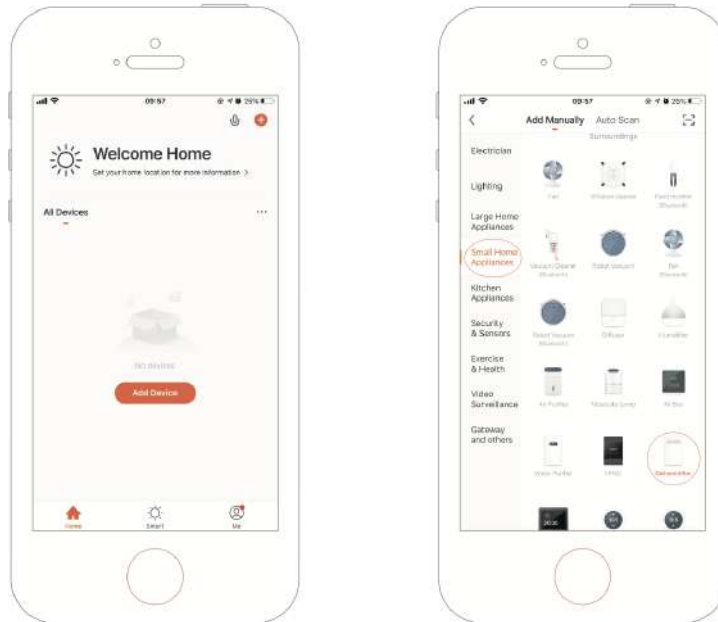

### Step 2

Confirm the indicator rapidly blink and enter the WiFi password.

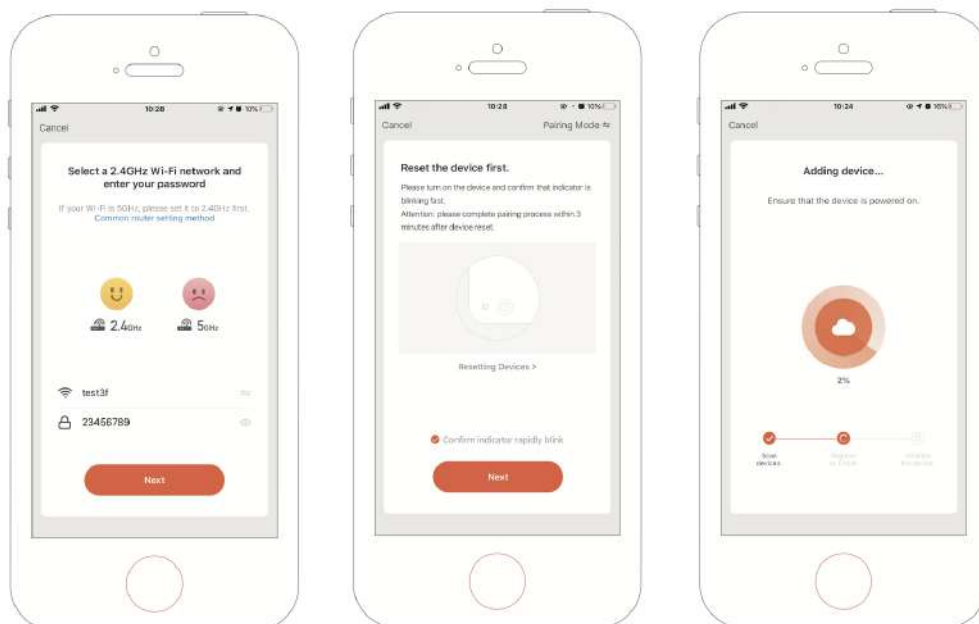

# SMART CONNECTION OPERATION GUIDE

## Step 3

Complete the connection to set the dehumidifier with APP.

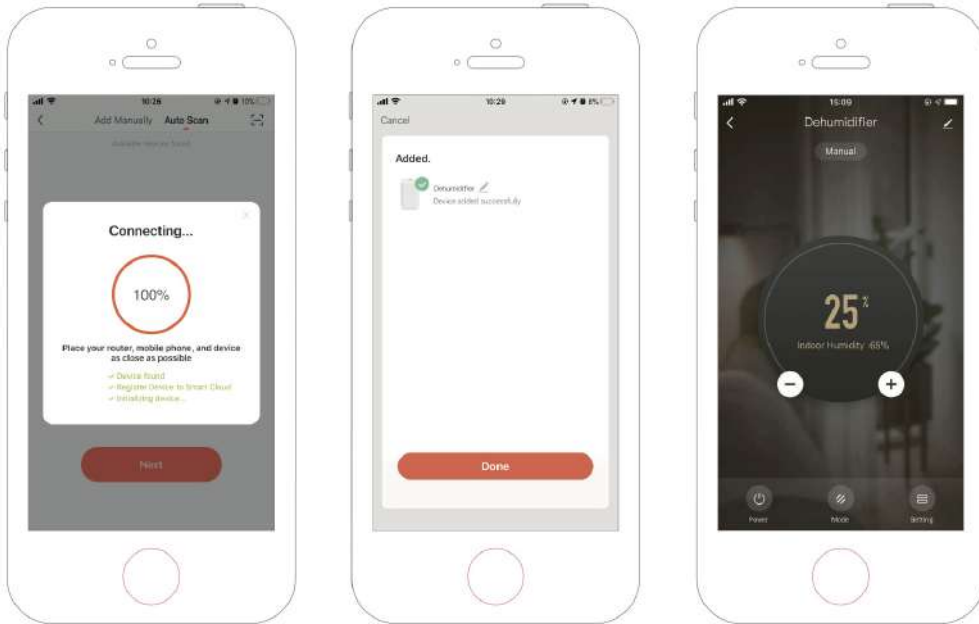

## CONDITIONS OF WARRANTY

**There is a two-year warranty on your dehumidifier from the date of purchase.**

The following applies:

1. Any repairs or replacement of components during the warranty period will be not result in an extension of the warranty period.
2. The warranty will expire if any alterations have been made, not genuine components have been fitted or if the dehumidifier has been repaired by a third party.
3. Components subject to normal wear and tear, such as the air filters, are not covered by the warranty.
4. The warranty is only valid on presentation of the original, unaltered, and date-stamped purchase receipt.
5. The warranty is not valid for:
  - Damages is caused by actions that deviate from those as described in the user's manual or by neglect.
  - Damages caused from intervention of unauthorized personnel.
  - Bad or insufficient maintenance.
  - Factors for which the production factory does not have any responsibility (variations in power supply beyond the specifications of the unit, etc.), connection in non-grounded power supply socket etc.
  - All claims for compensation, including consequential damage, will not be entertained.
6. In case of any unit's damage you should refer to the company that sold the unit.
7. The transportation costs from and back to technical department and the probable insurance of the units are under the customer's choice and responsibility.



**SANI HELLAS IMPORT EXPORT TECHNICAL SA**  
distributor of Kullhaus products in Greece

**Sani hellas**  
AIR TREATMENT

**SANI HELLAS**

IMPORT EXPORT TECHNICAL SA  
5-7 Kosti Palama Str.  
143 43 Athens, Greece  
Tel. (+30) 210 3236627, 3233766  
Fax (+30) 210 3247709  
e-mail: [info@sanihellas.gr](mailto:info@sanihellas.gr)  
[www.sanihellas.gr](http://www.sanihellas.gr)

[www.kullhaus.com](http://www.kullhaus.com)